

Christmas Tree + Flashing Lights

Student Activity

7 8 9 10 11 12



TI-Nspire™



Investigation



Student



50 min

Introduction

Cartesian coordinates are a way of identifying the location of points on a 2 dimensional plane (x,y) or in 3 dimensional space(x,y,z). We can use these points systematically to construct diagrams and/or pictures. In the activity you will use your mathematical and artistic skills to create an image. We will start with a simple image then move you to a more challenging one. Then you will be able to construct your own using the skills and knowledge you gain. We will then use some conditional formatting to create blinking lights for your Christmas Tree.

Drawing a Square

Here is a diagram of the square that you will draw.

Firstly, you must identify the points used to create the image. In this case the four vertices of the square.

The four vertices' coordinates are:

(1,5) (,) (,) (,)

Let's write them in a tabular form.

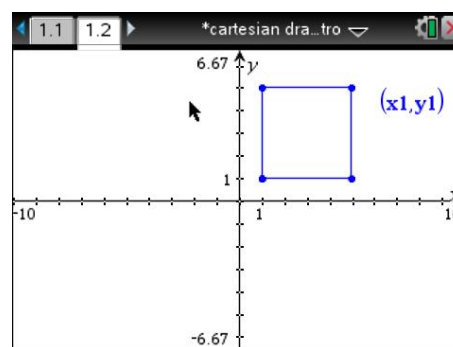

Be systematic, write them in the order you would follow if you were joining each point to the previous one.

For our first image this will be all the data you require.

x	y
1	5

Drawing a square on your calculator:

Insert a Lists and Spreadsheet application into a new document.

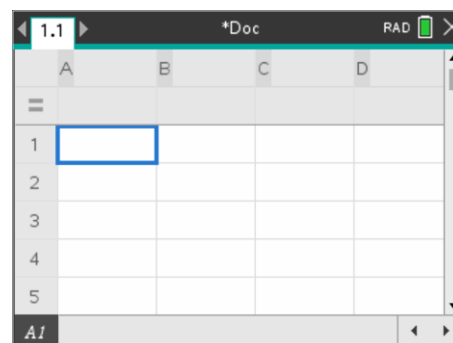

Name the first two columns: x1 and y1

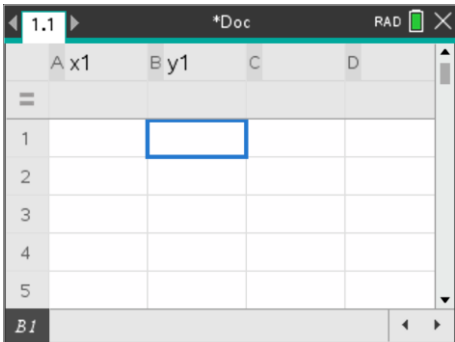

It is here that you enter the coordinates.

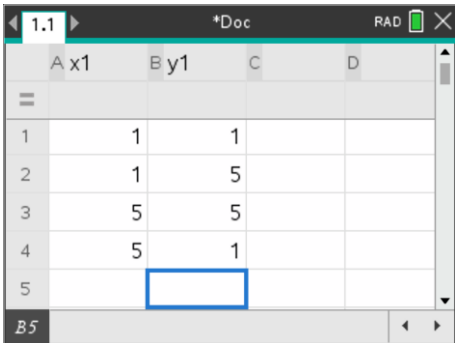

Now add a Graphs application, this is where the *drawing* will be displayed.

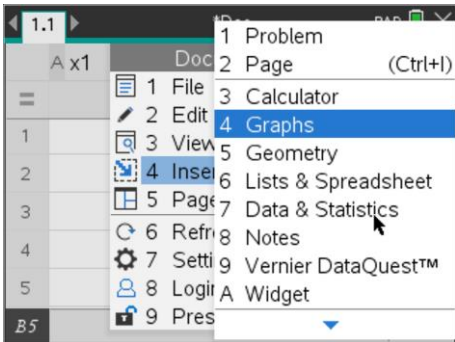

Select the Graph Entry/Edit type.

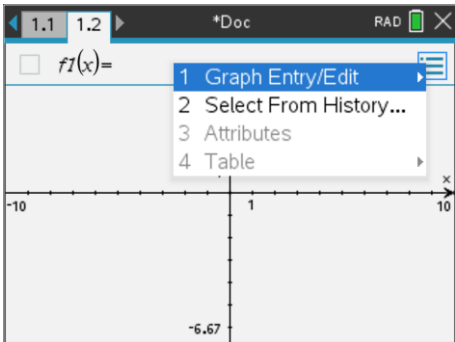

You need to select Scatter Plot.

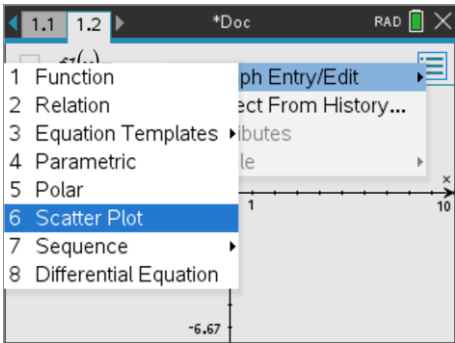

Now this Graph entry method should be displayed. (S1 = Scatter Plot 1)

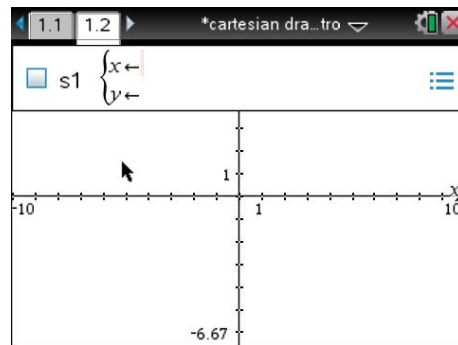

Let x be $x1$ and y be $y1$, the variables we defined in the Lists & Spreadsheet application.

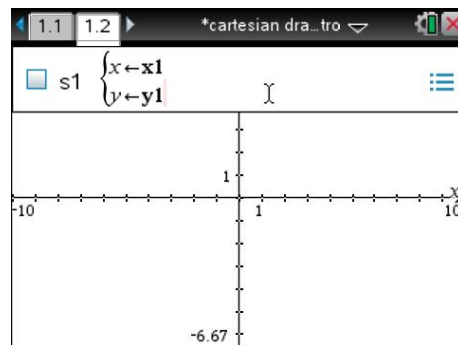

Your points will be displayed.

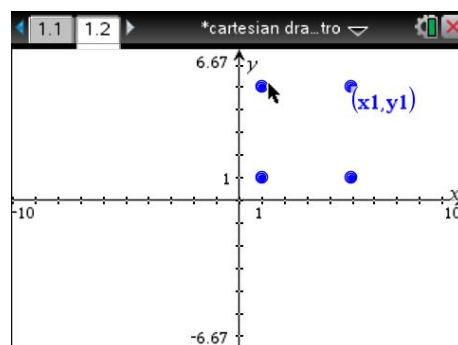

Next we have to join them up, press:

menu > **Actions** > **Attributes**

Click on one of the points.

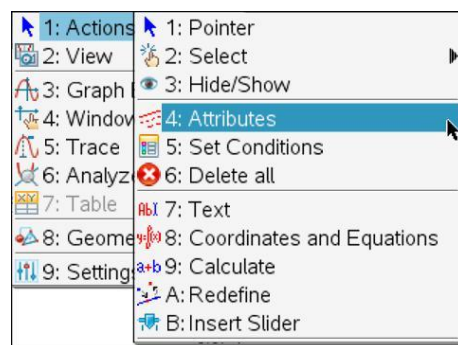

Select the middle attribute and change it to: "Points are Connected".

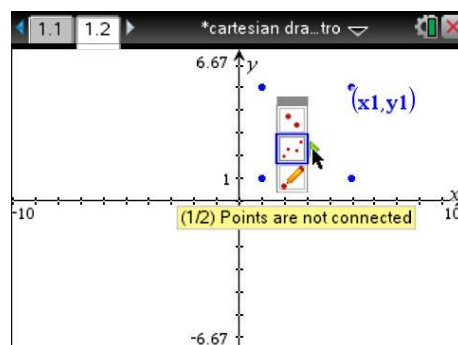

You will notice now the shape is not completed.

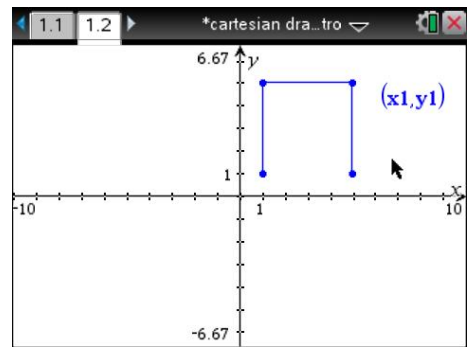

In order to join the shape up, the initial point must be added to the end of your points list.

	A	x1	B	y1	C	D
=						
2		1		5		
3		5		5		
4		5		1		
5		1		1		
6						

Your shape should be complete.

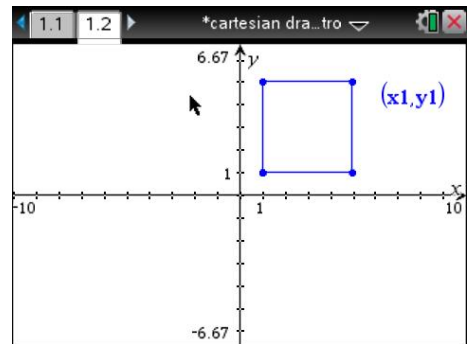

Drawing a Christmas Tree on your Calculator

Now try this set of data:

X ₁	0	0	2.5	1.5	2	1	1.5	0.5	1	0
Y ₁	0	1	1	3	3	5	5	7	7	9
X ₁	-1	-0.5	-1.5	-1	-2	-1.5	-2.5	0	0	
Y ₁	7	7	5	5	3	3	1	1	0	

You may notice your image goes outside of the calculator window. You can change the window settings to ensure that all the data you entered will fit. Press:

[menu] > **Window/Zoom** > **Zoom - Fit**.

All your points should be visible now.

Note that the window is no longer 'square', it has been stretched to fit.

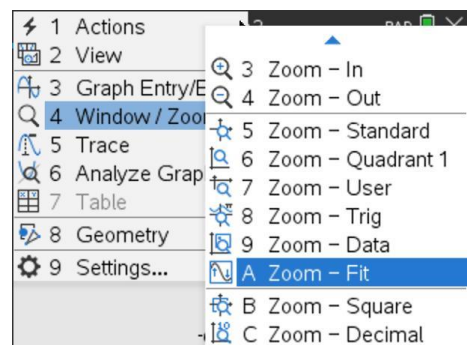

Adding the Lights:

Multiple sets of data can be graphed.

To create our lights, we will label the extra columns:

lightsx and lightsy

Graph them on the same axes as the tree.

	x1	y1	lightsx	lightsy
1	0	0	-1	5
2	0	1	-0.5	5
3	2.5	1	0	5
4	1.5	3	0.5	5
5	2	3	1	5

Here are two lines of lights, they don't need to be joined together.

lightsx	-1	-0.5	0	0.5	1	-1.5	-1	-1.5	-0.5	0	0.5	1	1.5
lightsy	5	5	5	5	5	3	3	3	3	3	3	3	3

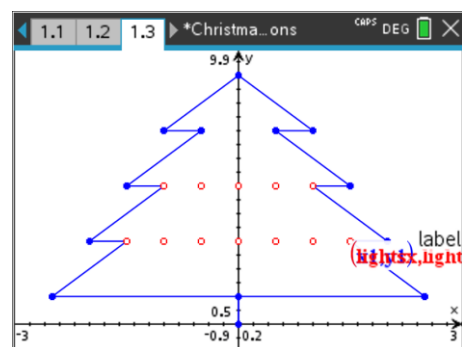
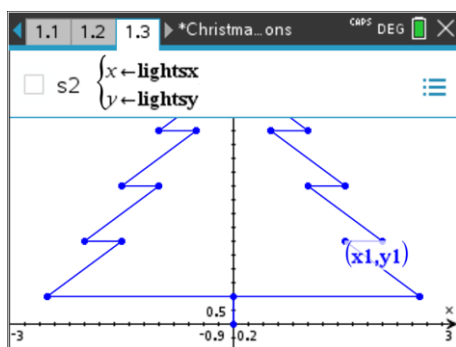

These will be the points that we will make flash different colours.

First let us delete the **labels** for the sets of points (x1,y1) and (lightsx , lightsy)

Select the labels, then press: **ctrl** + **menu** and delete them.

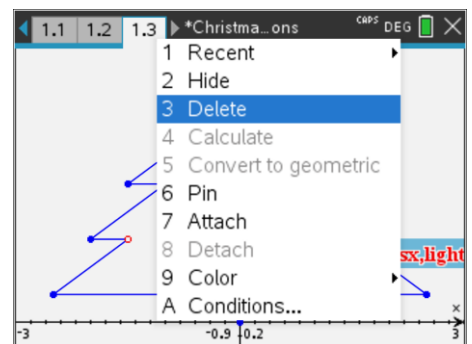

The points that represent the Christmas lights can be altered by changing their attributes to make them more decorative.

Select the lights scatterplot and change their attributes to: "Larger".

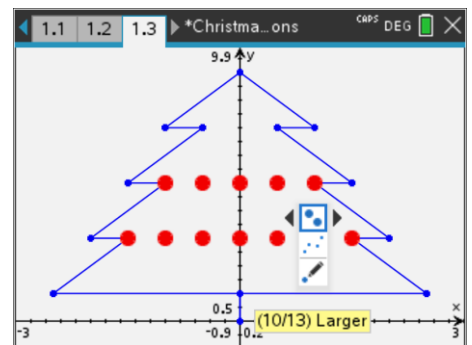

You can also select the tree and change its colour to green.

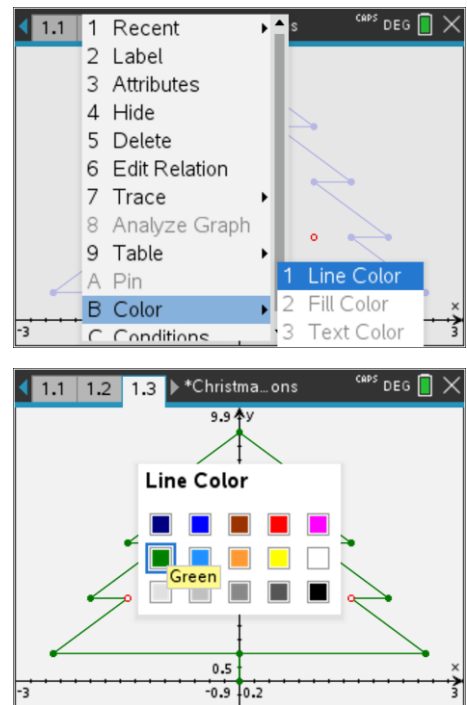

Flashing Lights:

Create a slider, call it: "blink".

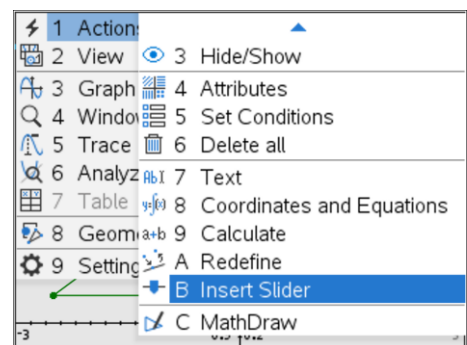

Note the values:

Minimum = 0

Maximum =3

Step Size 1

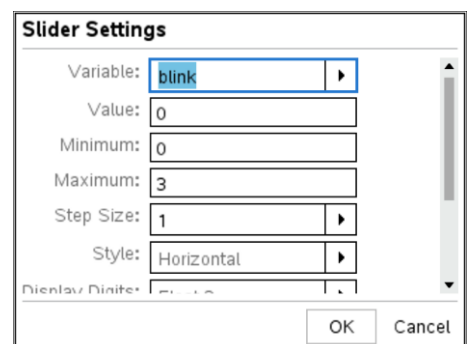

Select the lights scatterplot. Press: **ctrl** + **menu** and select conditions.

The conditional attributes can control when a graph, point or set of points are visible and their colour.

Blink is the value of the slider either 0, 1, 2 or 3

As the slider values change so do the colour of the lights.

Here is the code to enter into the line colour:

```
when(blink=1,7,when(blink=2,6,when(blink=3,2,9)))
```

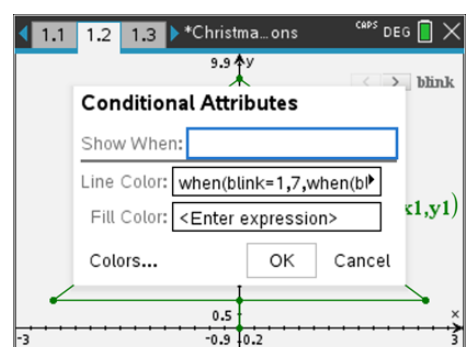

Now select the slider, press **ctrl** + **menu** and select Animate.

You should now have flashing lights!

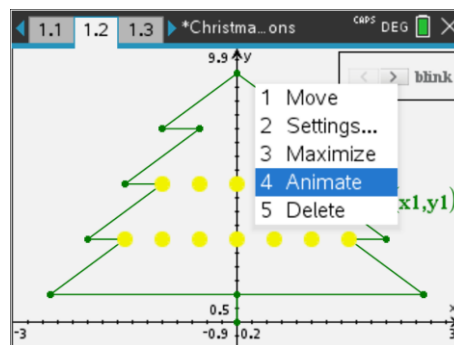

For your Reference



Extension:

Now you have built the basic Christmas tree, try adding more features such as:

- More lights
- Another set of lights with alternate blinking
- A star on the top
- Ornaments on the tree
- Presents underneath the tree
- A bushier looking tree.